



## Adit Phone - GRP2613



## Connecting Your Adit Phone

- **Step 1:** Find the ethernet cable connecting your computer to your wall socket or router.
- **Step 2:** Unplug the end connected to your computer and plug it into the LAN port on the back of the phone.
- **Step 3:** Connect an additional ethernet cable from your computer into the PC port on the back of the phone.
- **Step 4:** Connect the 12V DC plug to the power jack on the phone, and the other end into an outlet.

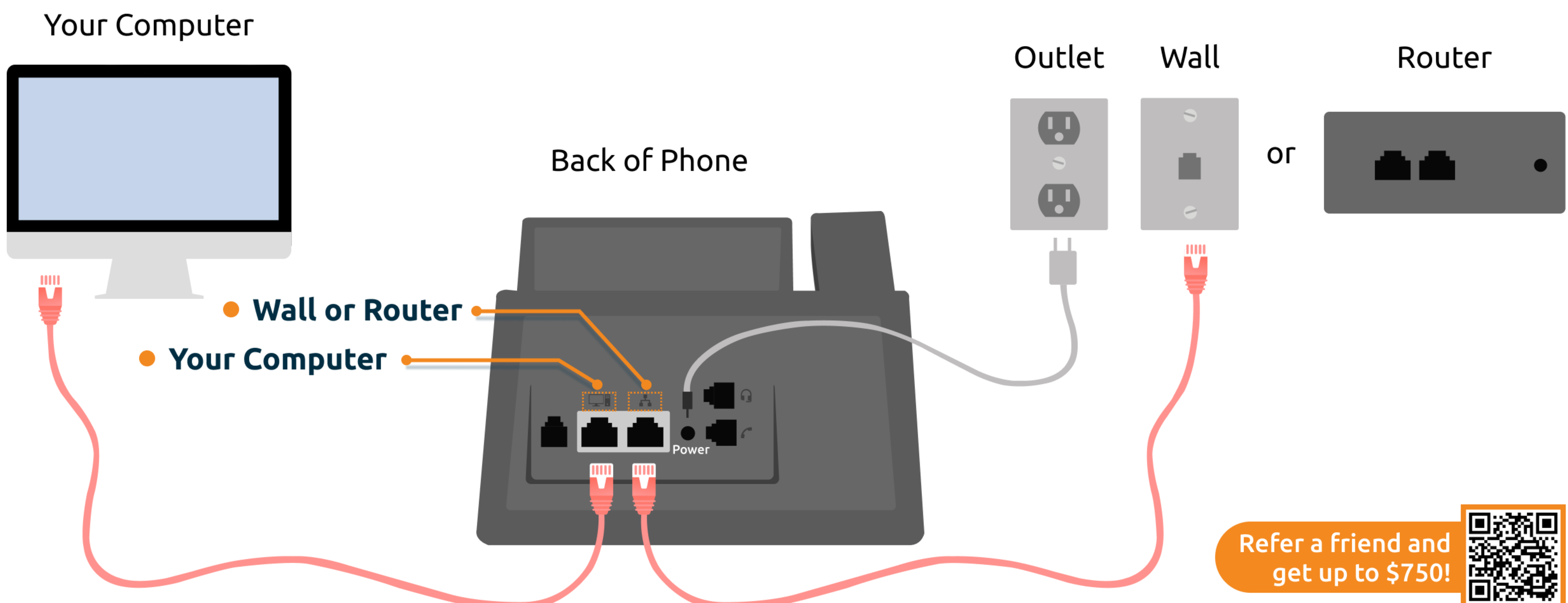

## Using Your Adit Phone

- **Call Park:** Press the park soft key and the call will park in that designated slot. A red light will appear across all of your phones to indicate that a call has been parked. Press the park soft key to pick up that call.

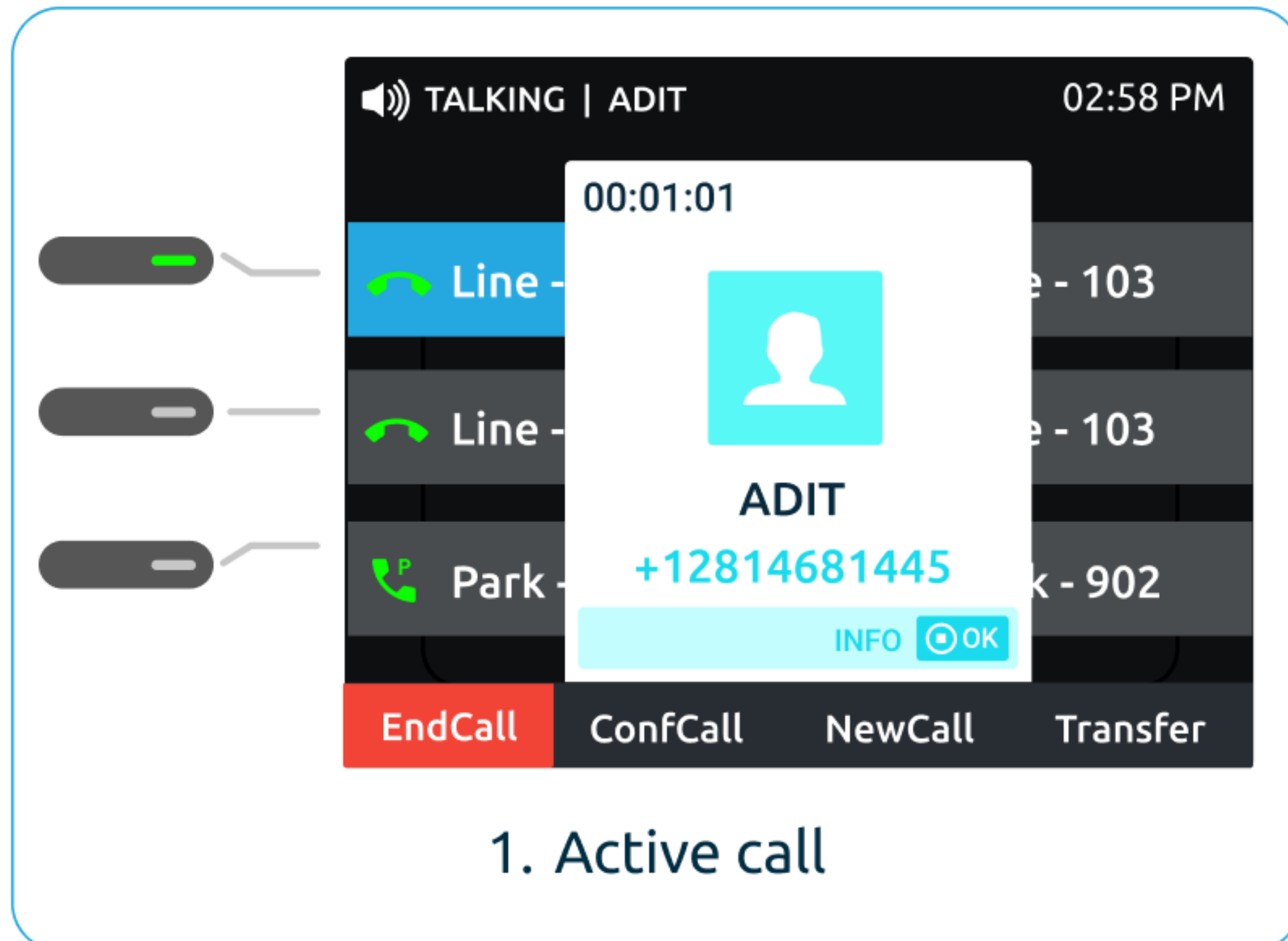

- **Call Hold/Resume:** Press the Hold button to place a call on hold and to resume the call.
- **DND Mode:** Press the mute button to turn Do not Disturb mode ON/OFF.
- **Headset mode:** Press the headset button to use the headset once it's connected.
- **Intercom:** Press the intercom soft key or dial 999.
- **Call Transfer:** There are two different ways to transfer a call, either a **blind transfer** or **attended transfer**.

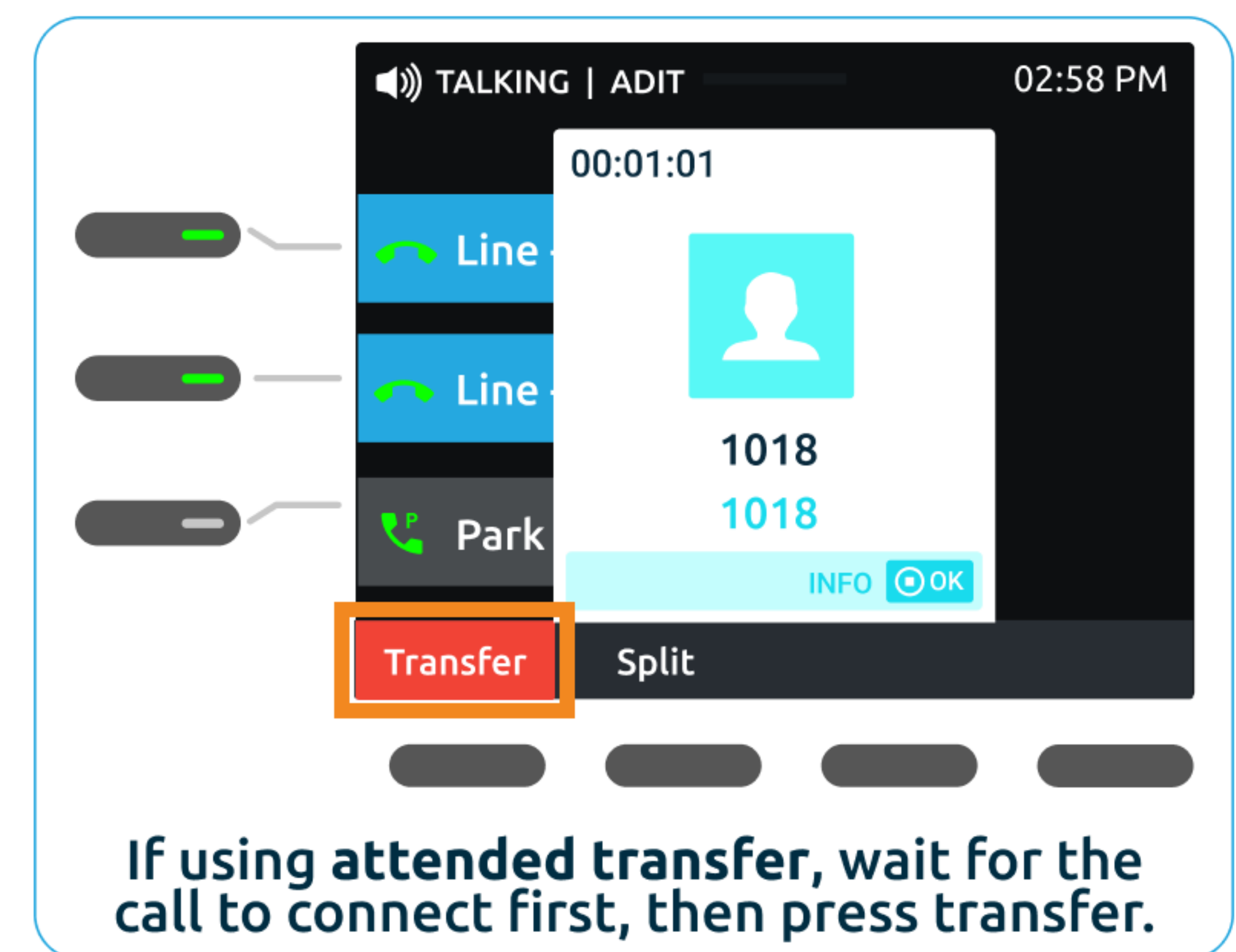
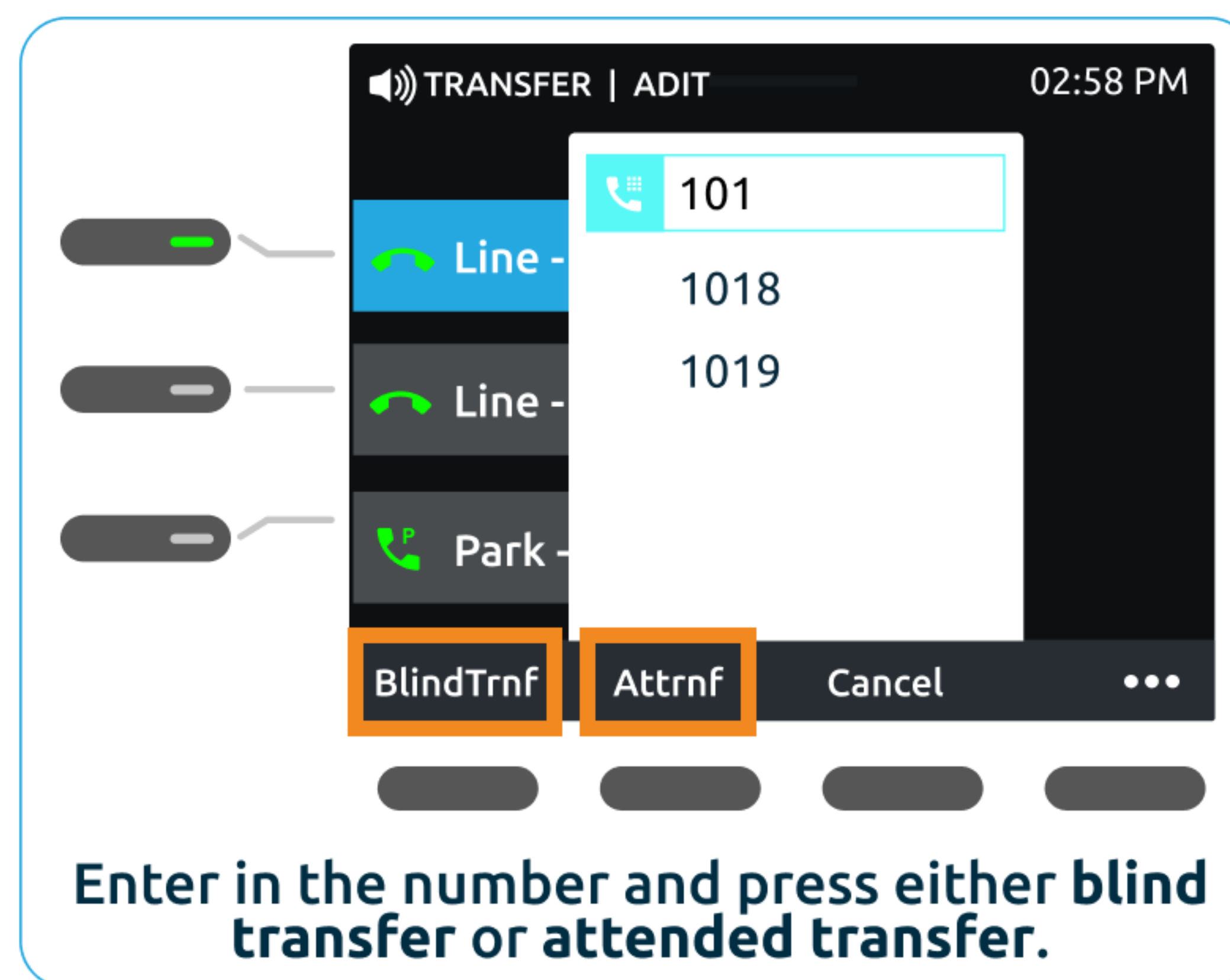
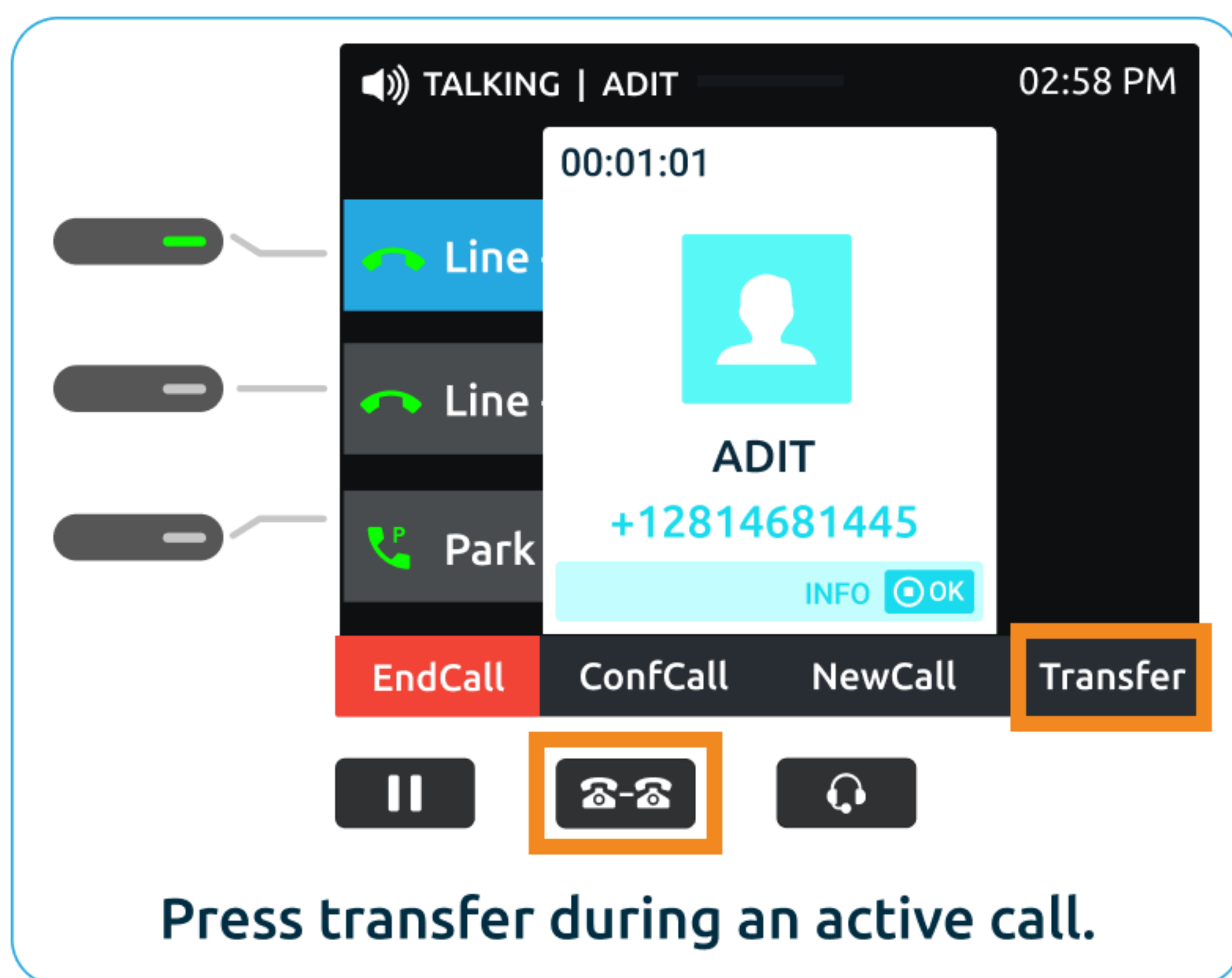

### 3 Way Conference:

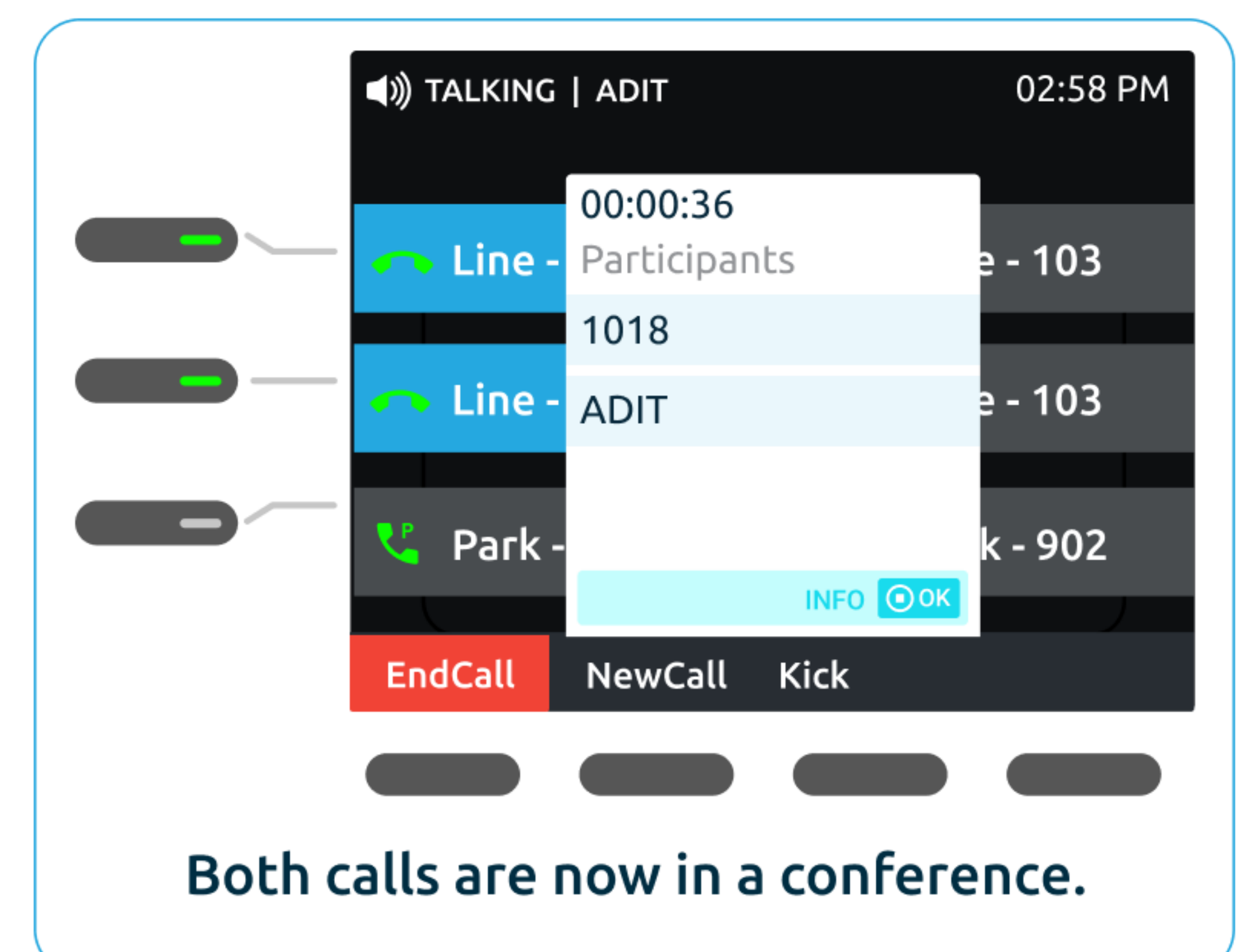
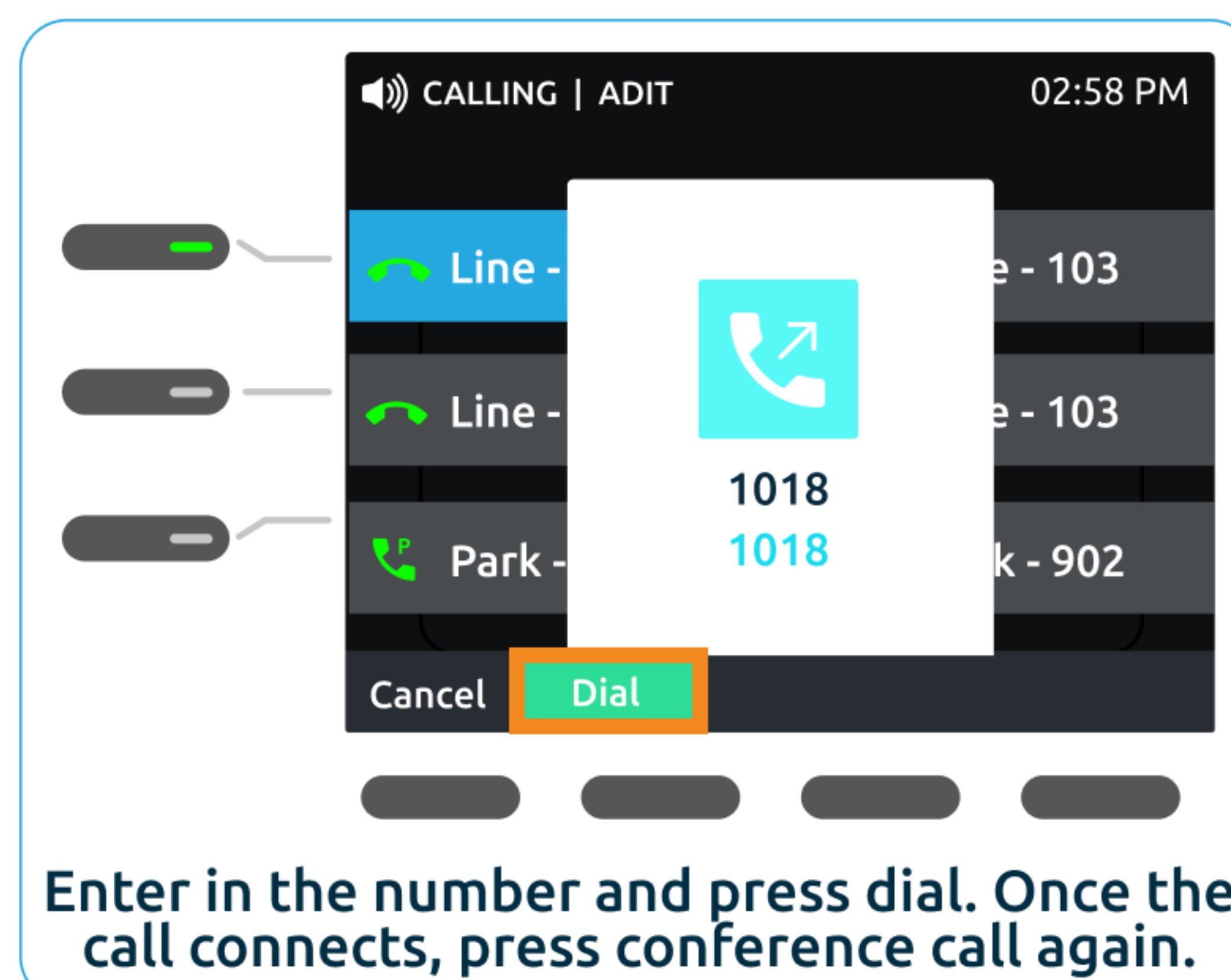
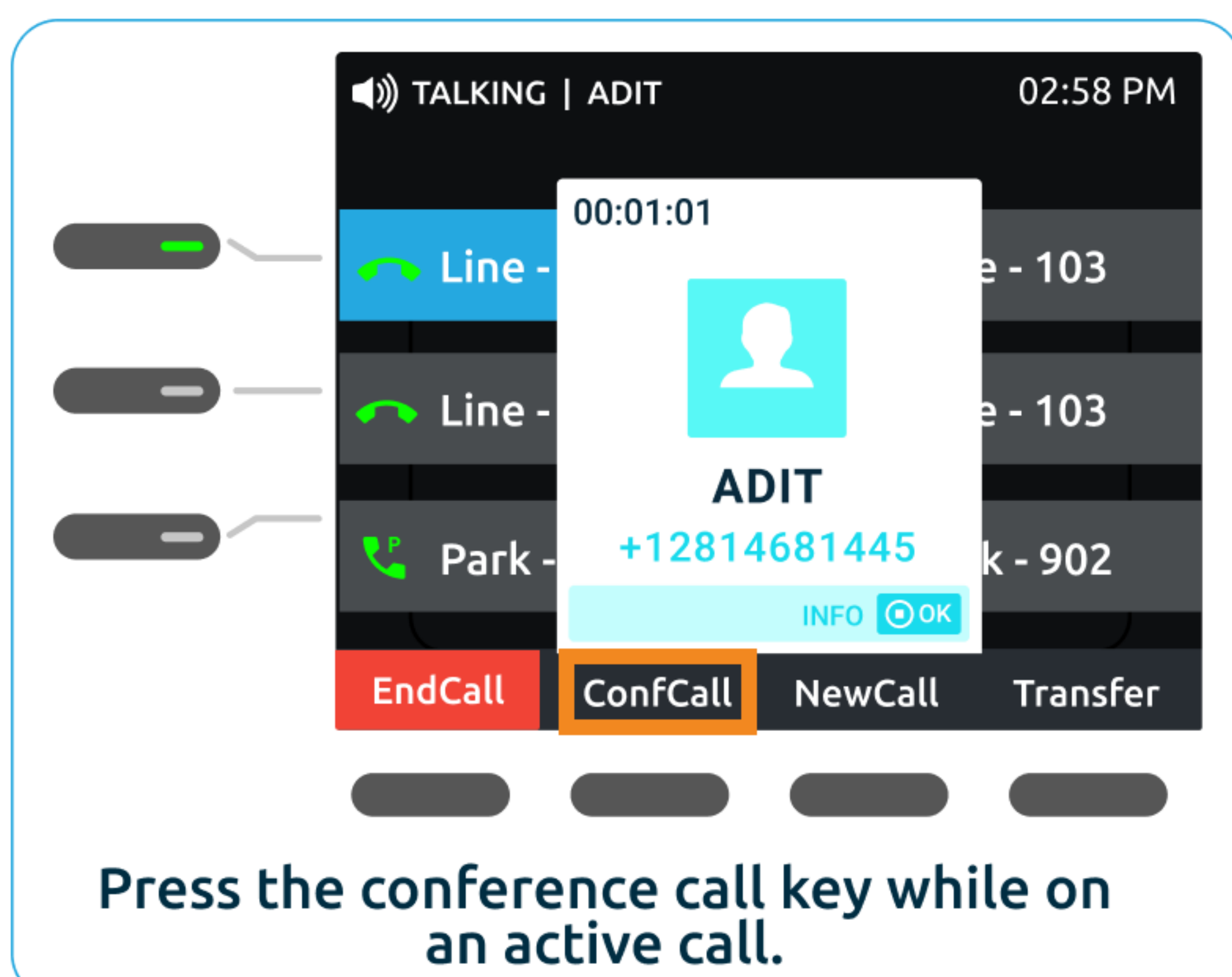



## Adit Phone - GRP2616



## Connecting Your Adit Phone

- Step 1:** Find the ethernet cable connecting your computer to your wall socket or router.
- Step 2:** Unplug the end connected to your computer and plug it into the LAN port on the back of the phone.
- Step 3:** Connect an additional ethernet cable from your computer into the PC port on the back of the phone.
- Step 4:** Connect the 12V DC plug to the power jack on the phone, and the other end into an outlet.

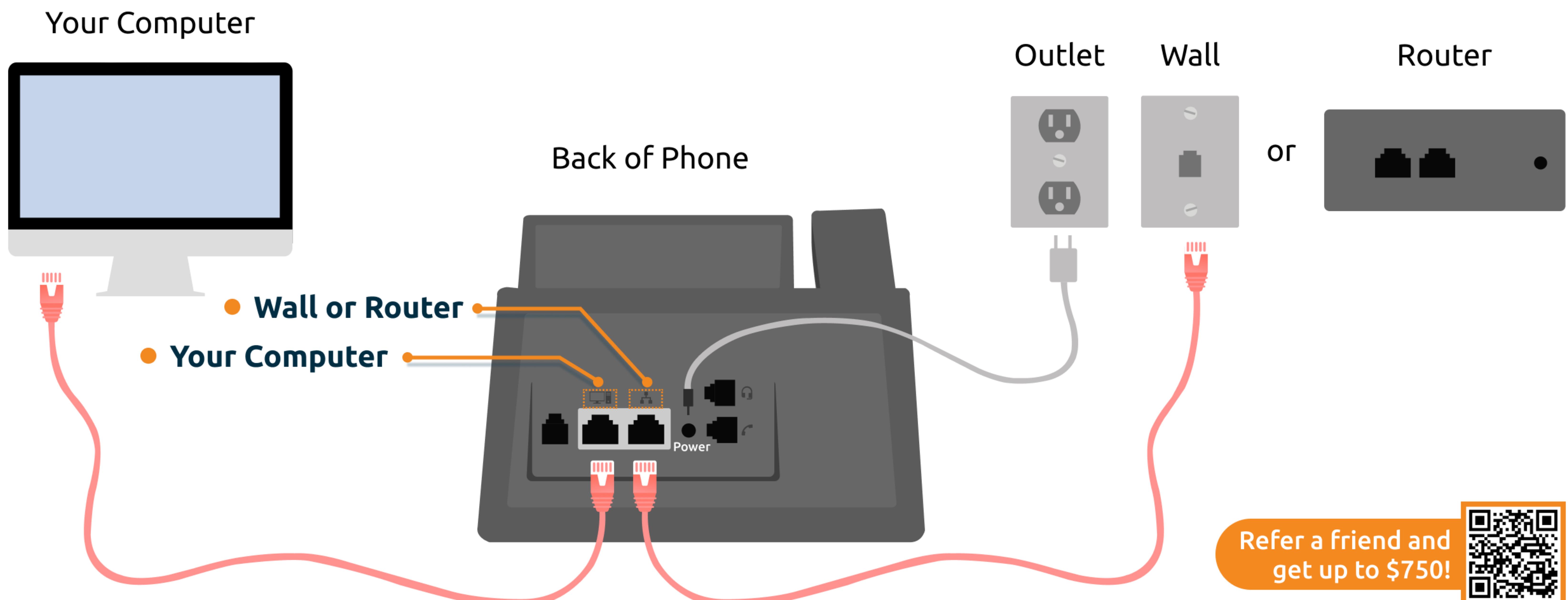

## Using Your Adit Phone

- **Call Park:** Press the park soft key and the call will park in that designated slot. A red light will appear across all of your phones to indicate that a call has been parked. Press the park soft key to pick up that call.

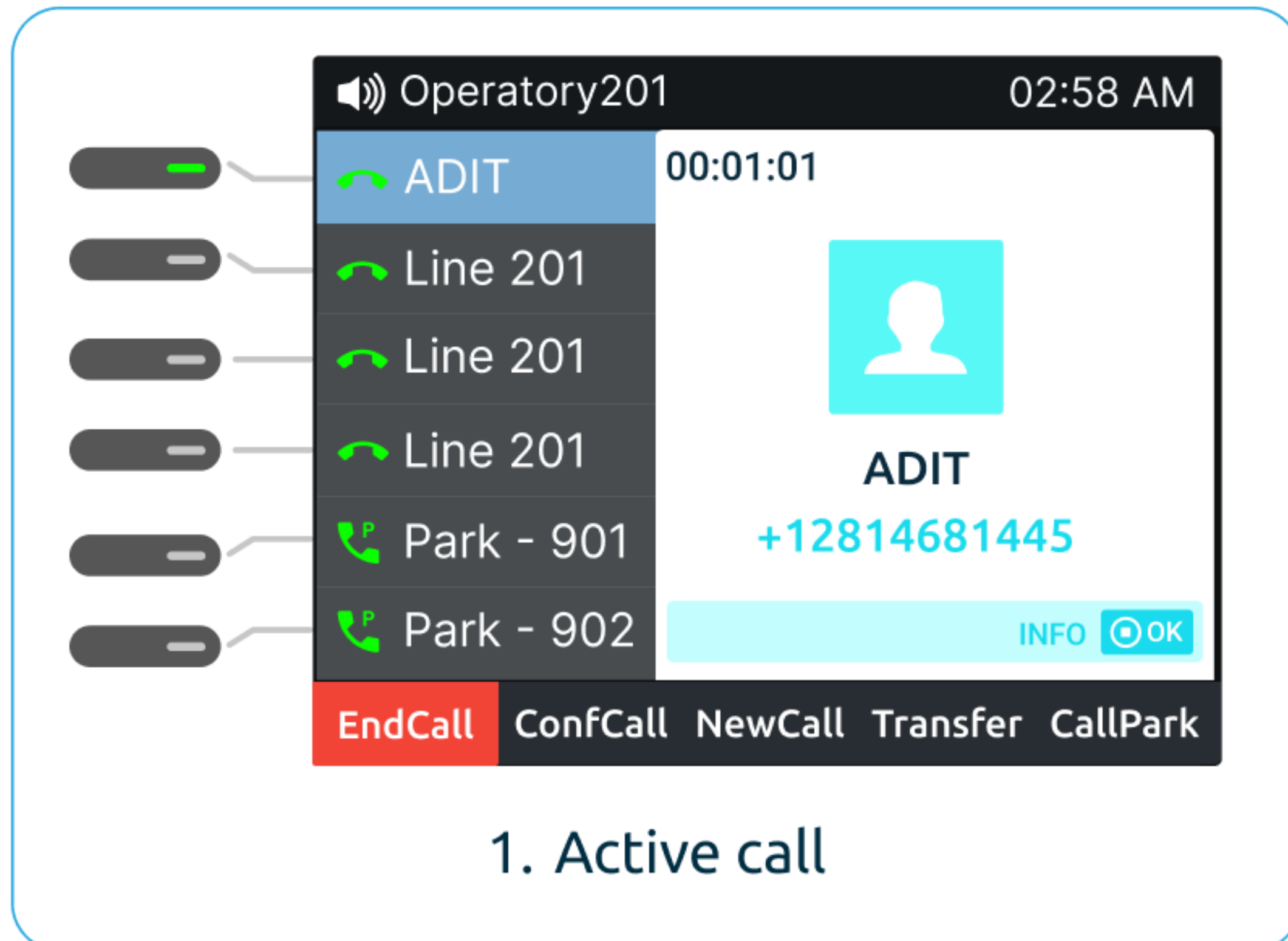

- **Call Hold/Resume:** Press the Hold button to place a call on hold and to resume the call.
- **DND Mode:** Press the mute button to turn Do not Disturb mode ON/OFF.
- **Headset mode:** Press the headset button to use the headset once it's connected.
- **Intercom:** Press the intercom soft key or dial 999.
- **Call Transfer:** There are two different ways to transfer a call, either a **blind transfer** or **attended transfer**.

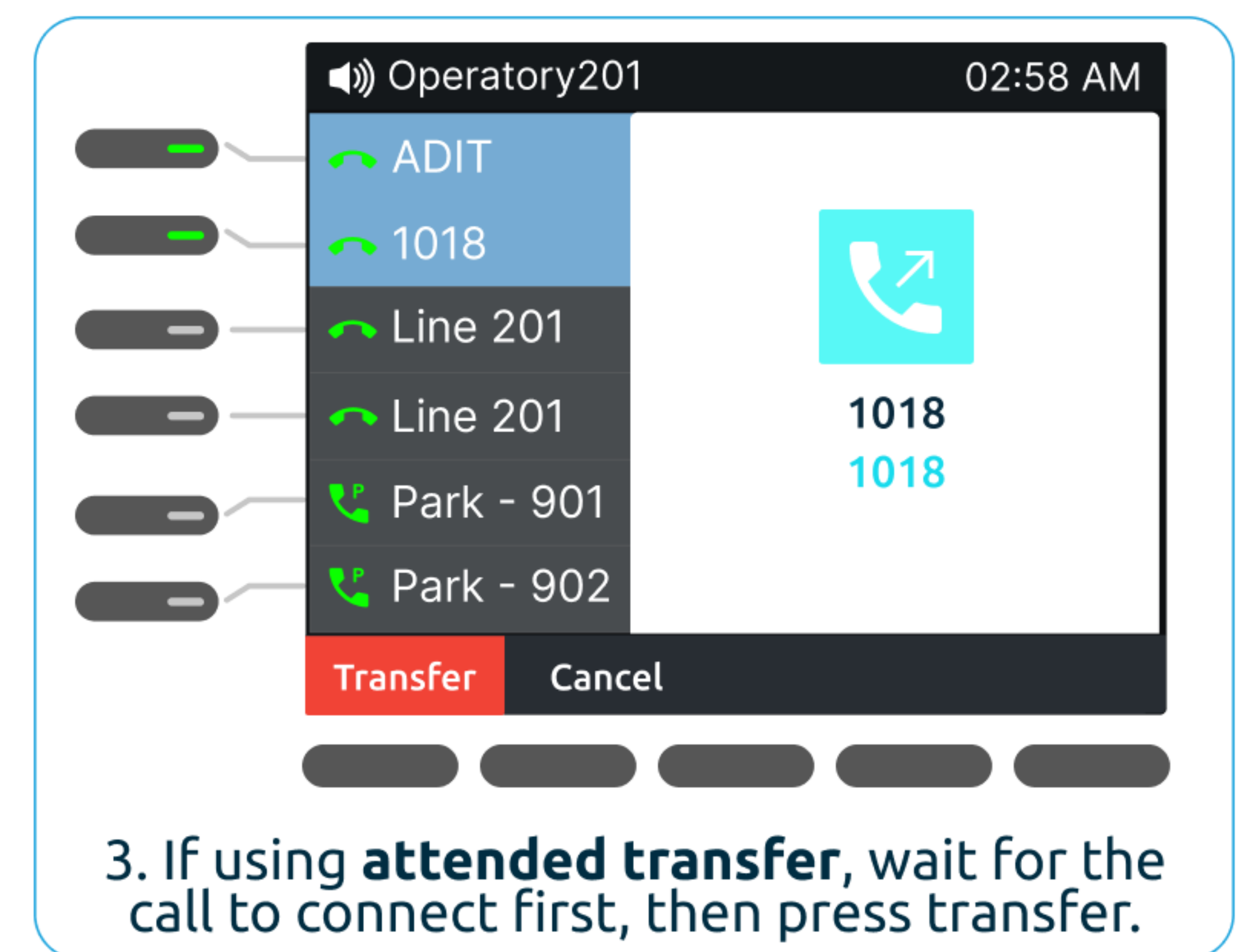
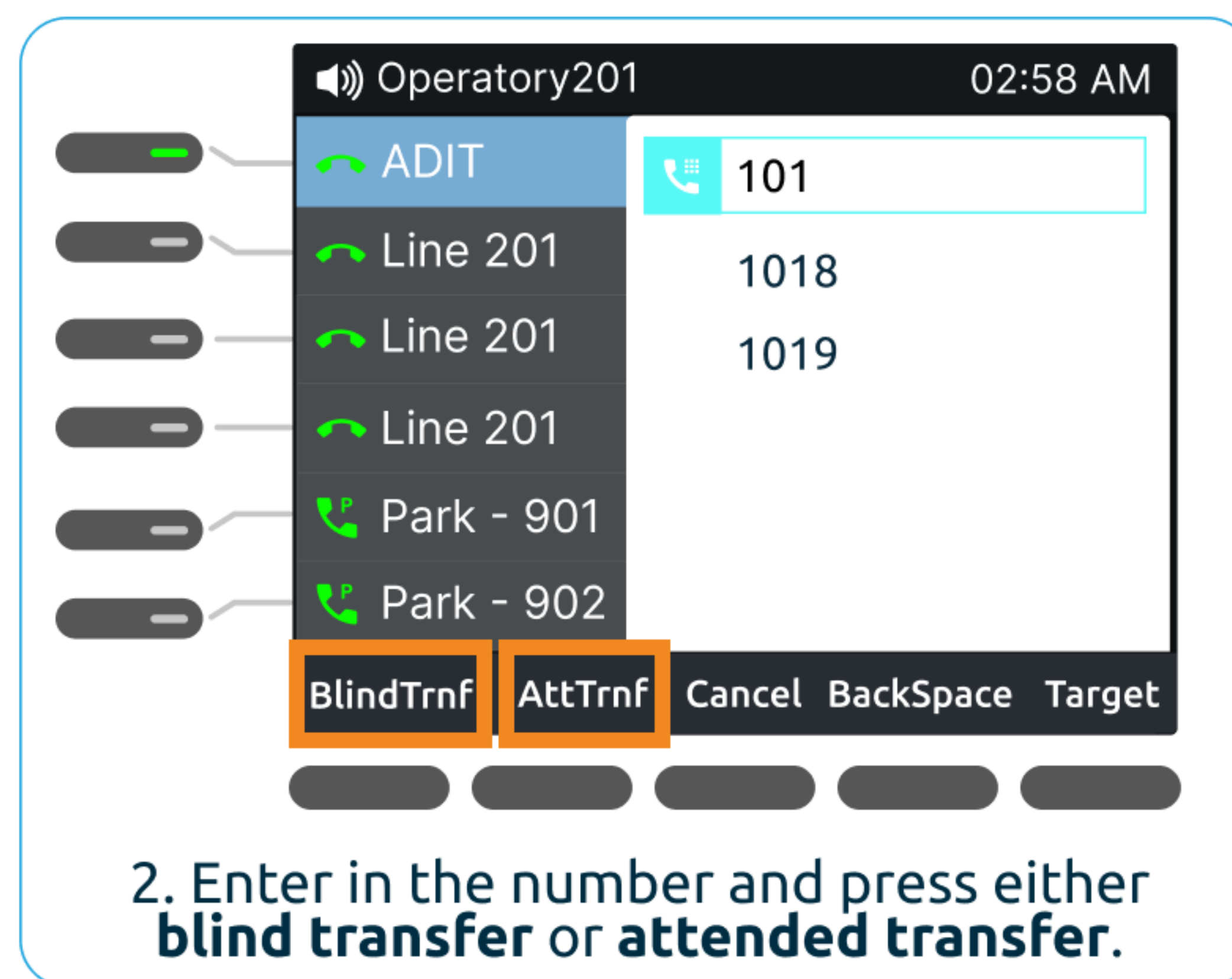
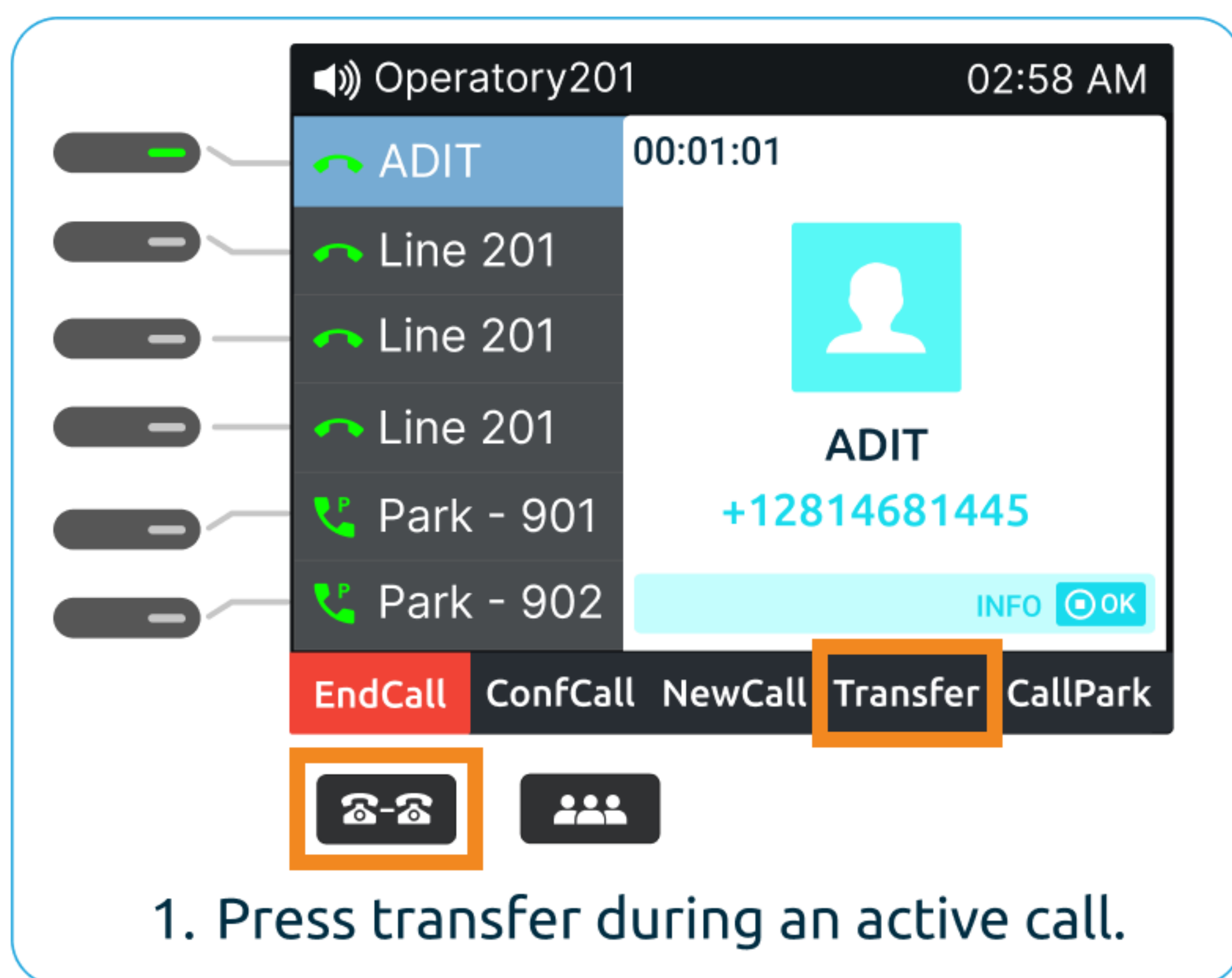

### • 3 Way Conference:

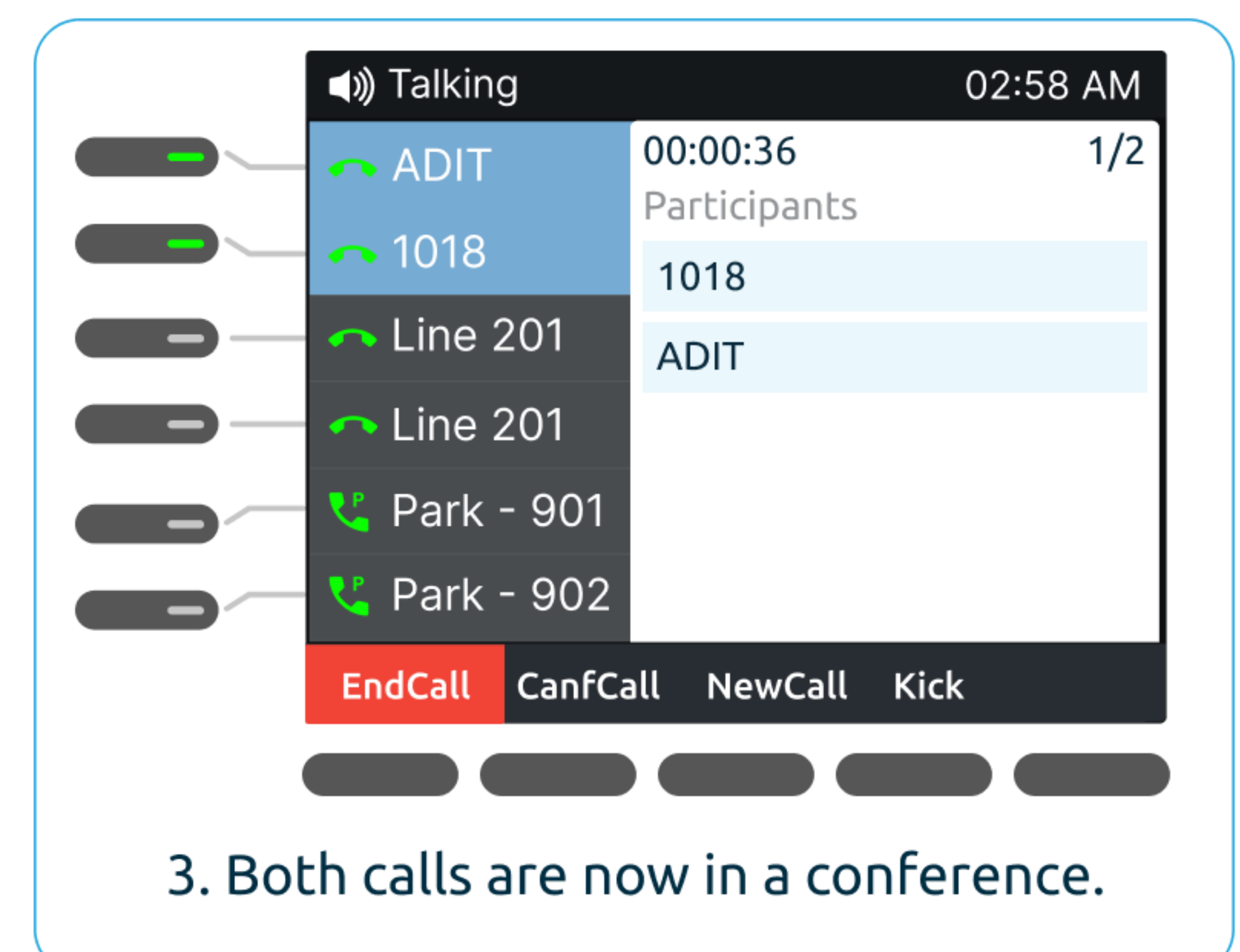
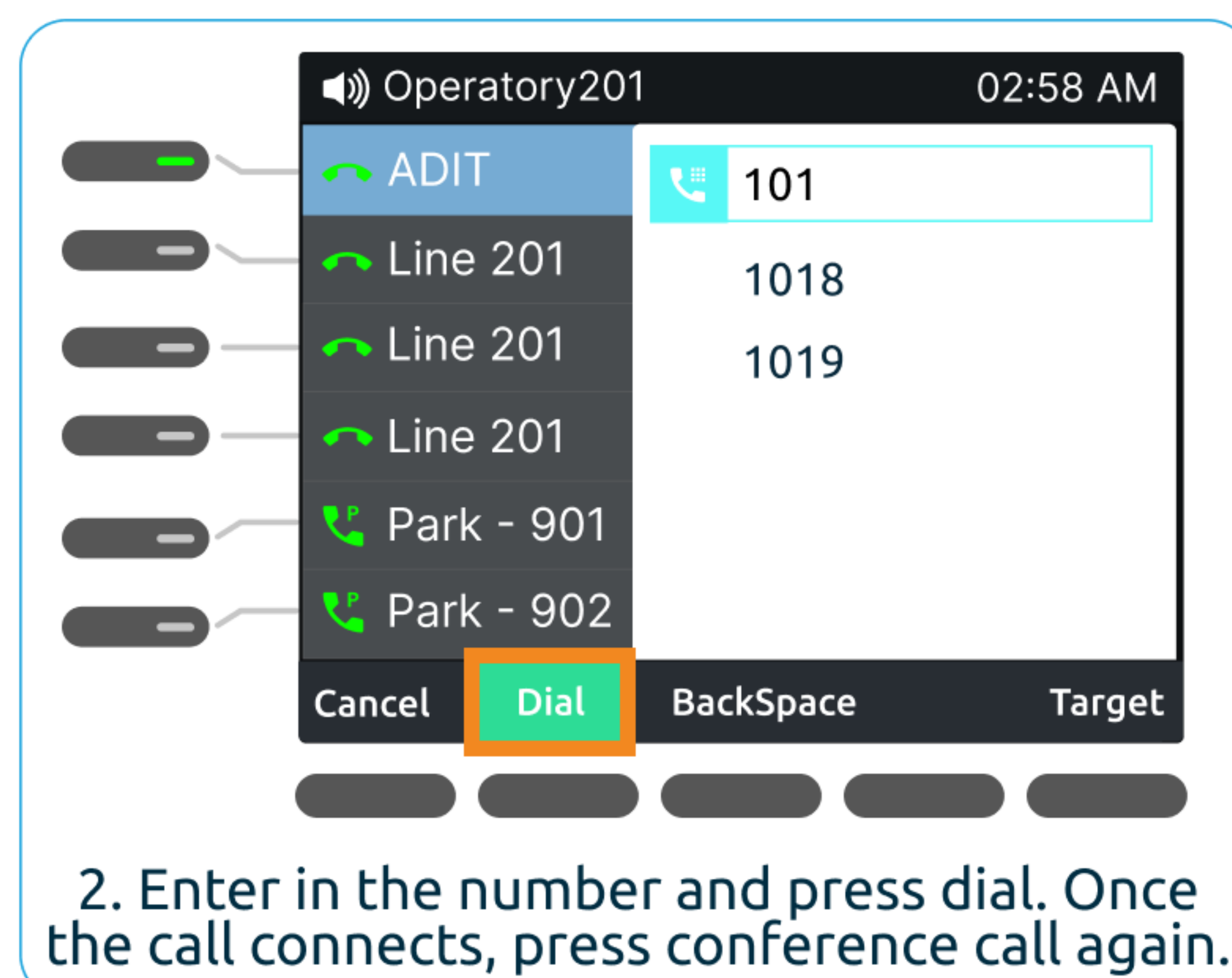
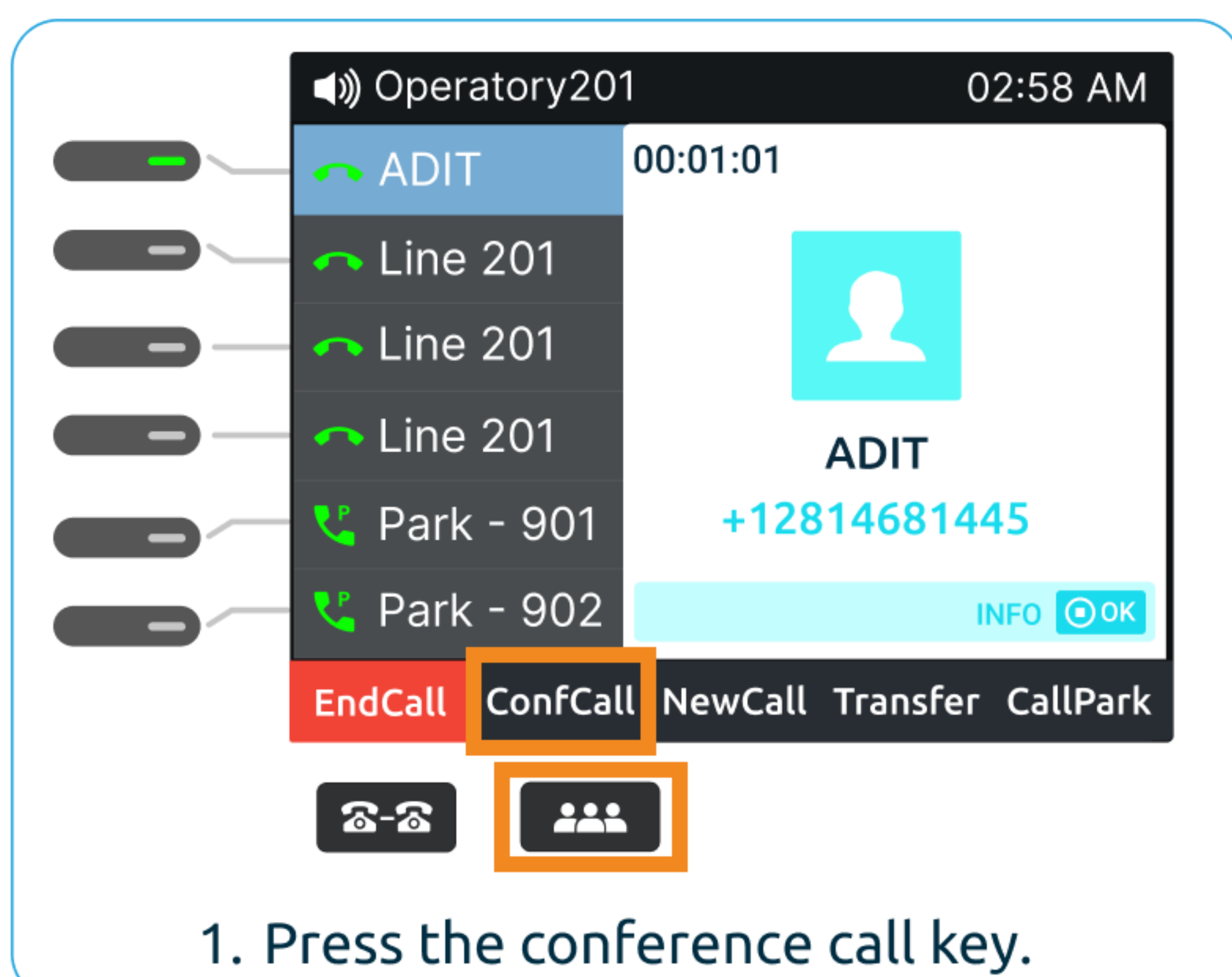



## Adit Phone - DP720



## Connecting Your Adit Phone

- Step 1:** To set up the DP720 (Wireless Phone), put the batteries into the handset and plug the charging base into an outlet. Press and hold the end key to turn on the phone.
- Step 2:** To set up the DP750 (Base Station), connect the micro-USB connector into the power port of the base station, and connect the other end into an outlet.
- Step 3:** Connect one end of the ethernet cable into the internet port and the other end into a router.
- Step 4:** Once the DP750 is on, the radio icon should start blinking. If it isn't, press and hold the radio button on the back of the base station for 7 seconds until it does. This will begin the subscription process.
- Step 5:** On the DP720, press the subscribe button and the devices will start pairing.

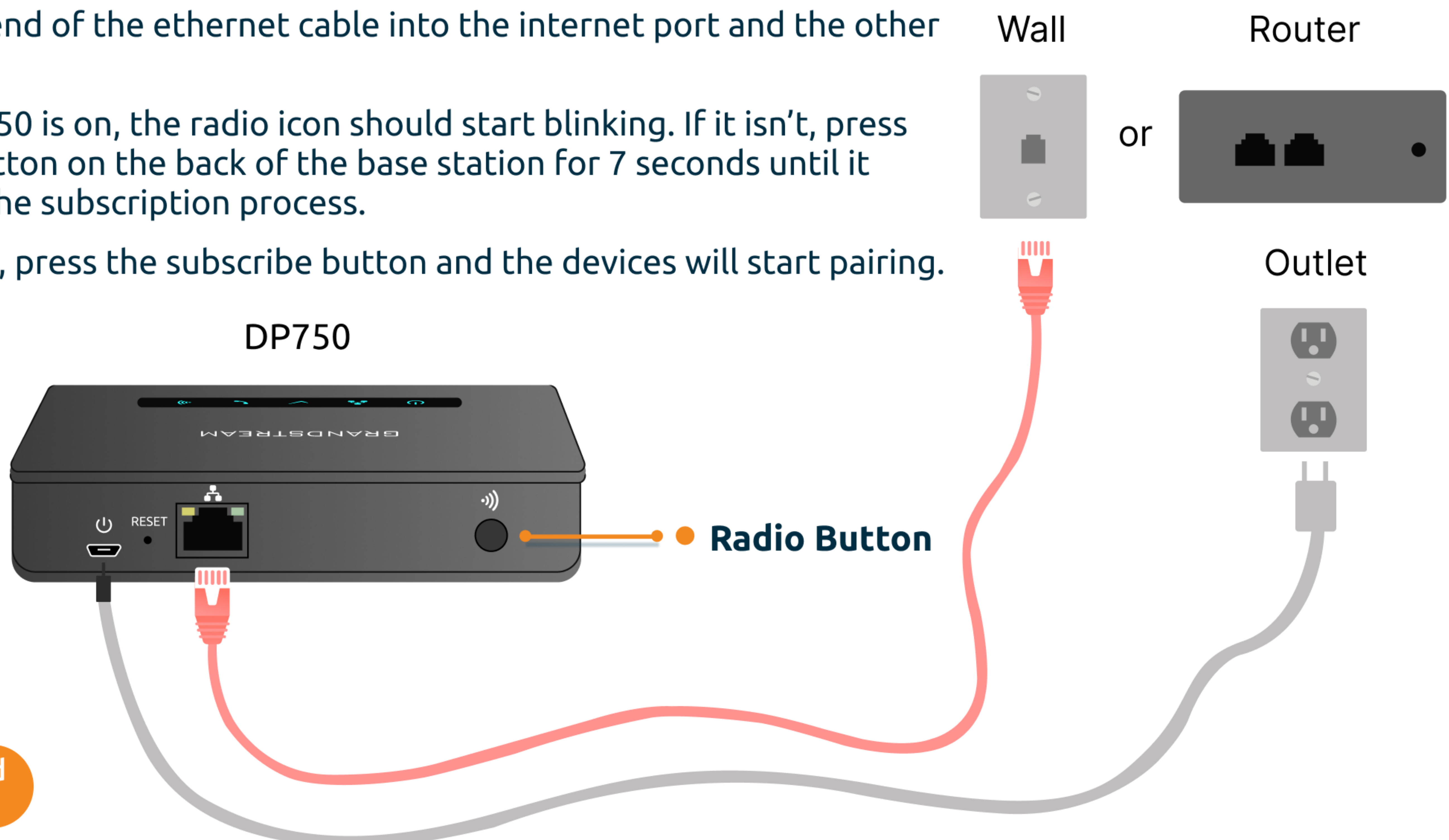

Refer a friend and get upto \$750!

## Using Your Adit Phone

- **Call Park:** You have 2 designated park slots - 901 and 902. Press the left soft key and select "Blind Transfer." Then dial either 901 or 902 and hit transfer, to park the call.

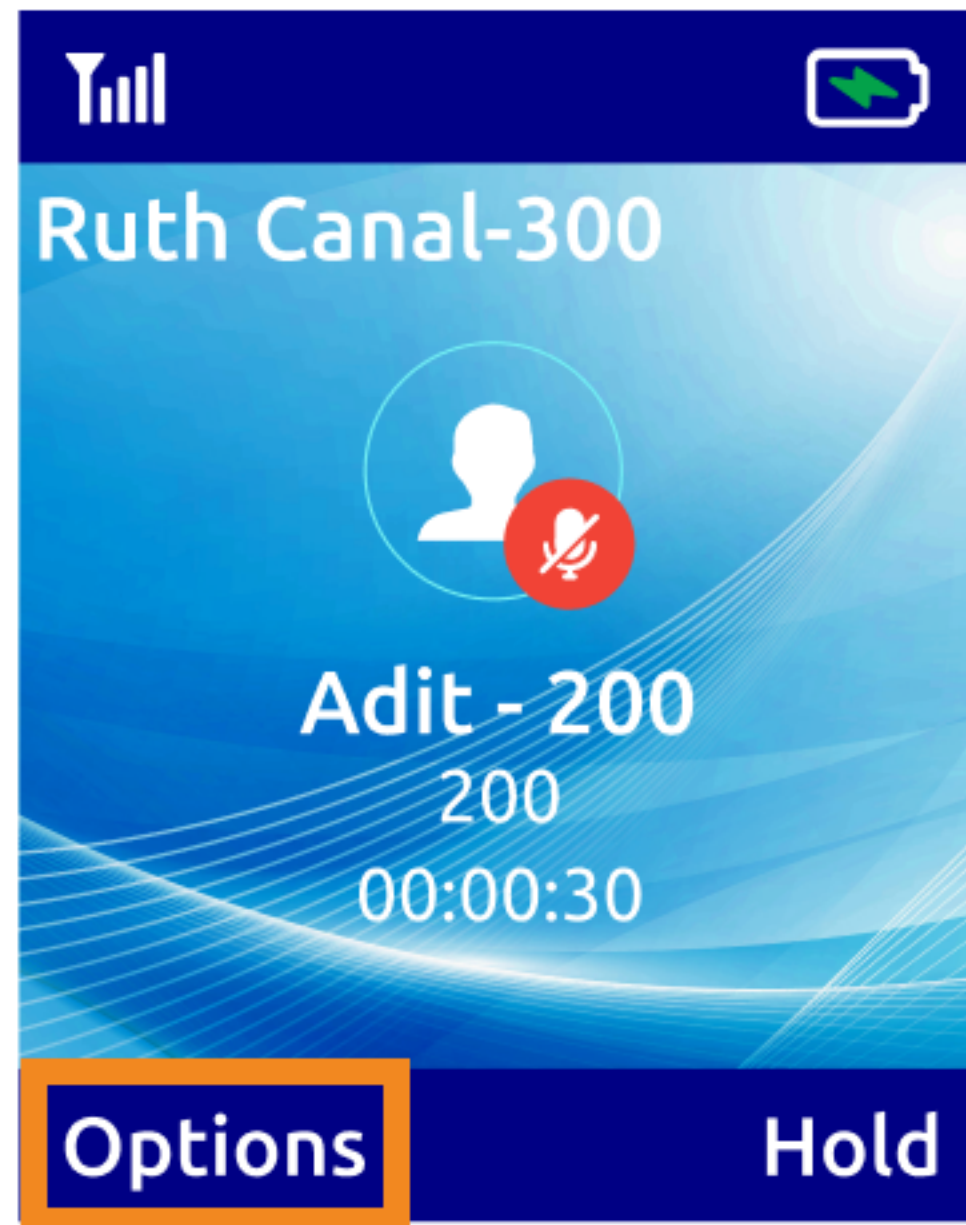

Click Options while on an active call

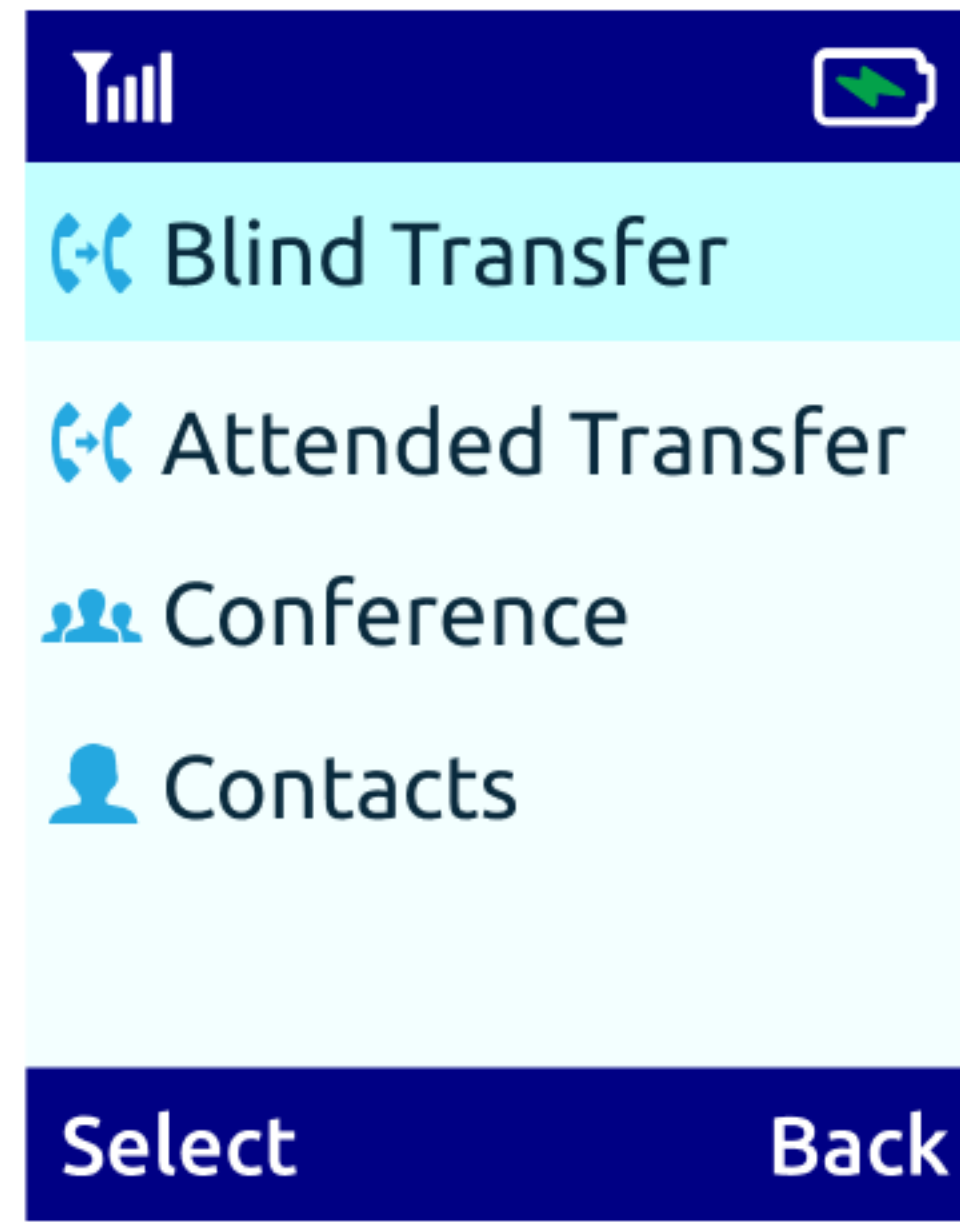

Select Blind Transfer

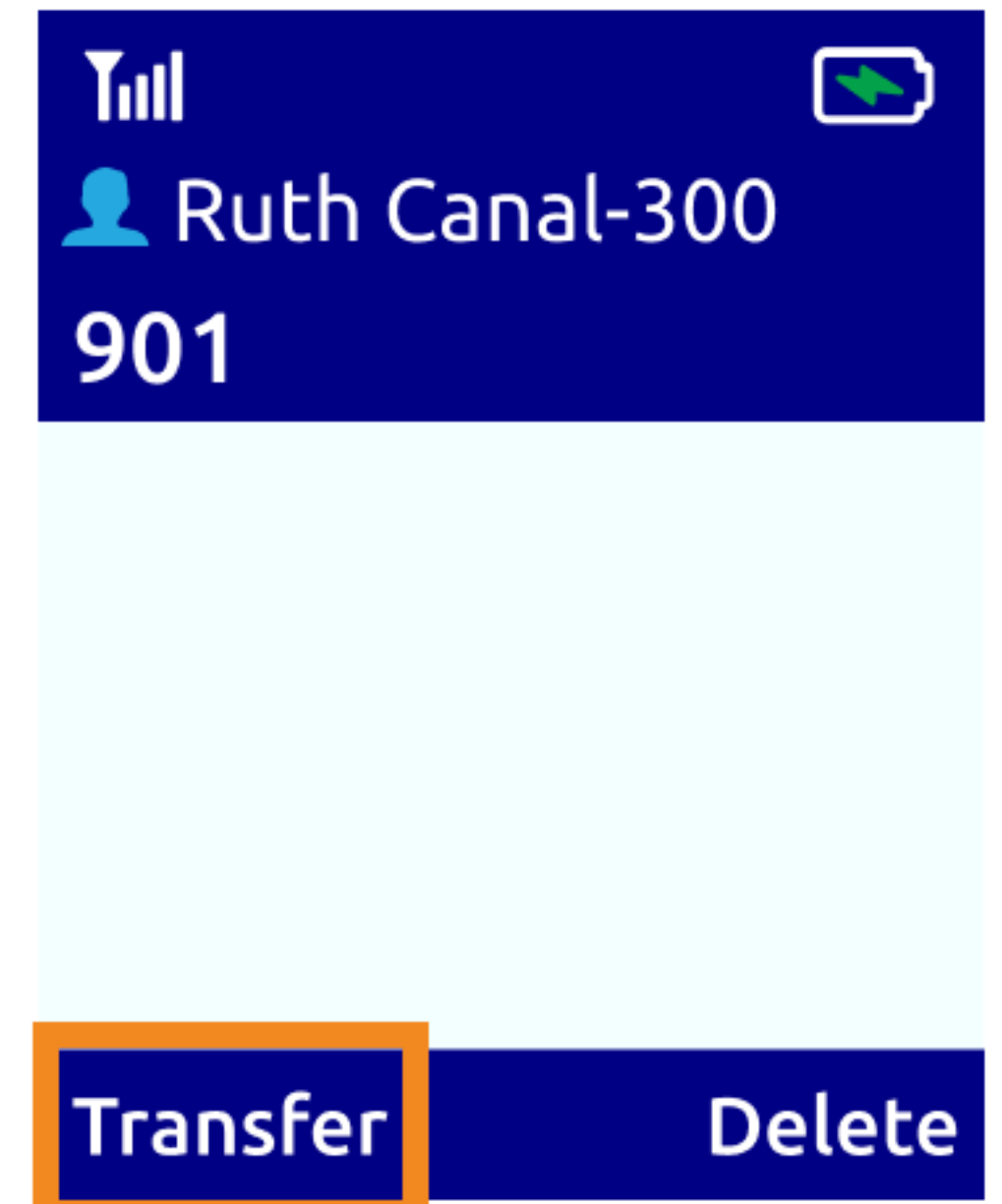

Transfer it to 901 or 902 to park the call

- **Call Hold/Resume:** While on an active call, press the right soft key to place a call on hold and to resume the call.
- **DND Mode:** Press the mute  button to turn Do not Disturb mode ON/OFF.
- **Intercom:** Dial 999.
- **Call Transfer:** There are two different ways to transfer a call, either a **blind transfer** or **attended transfer**.

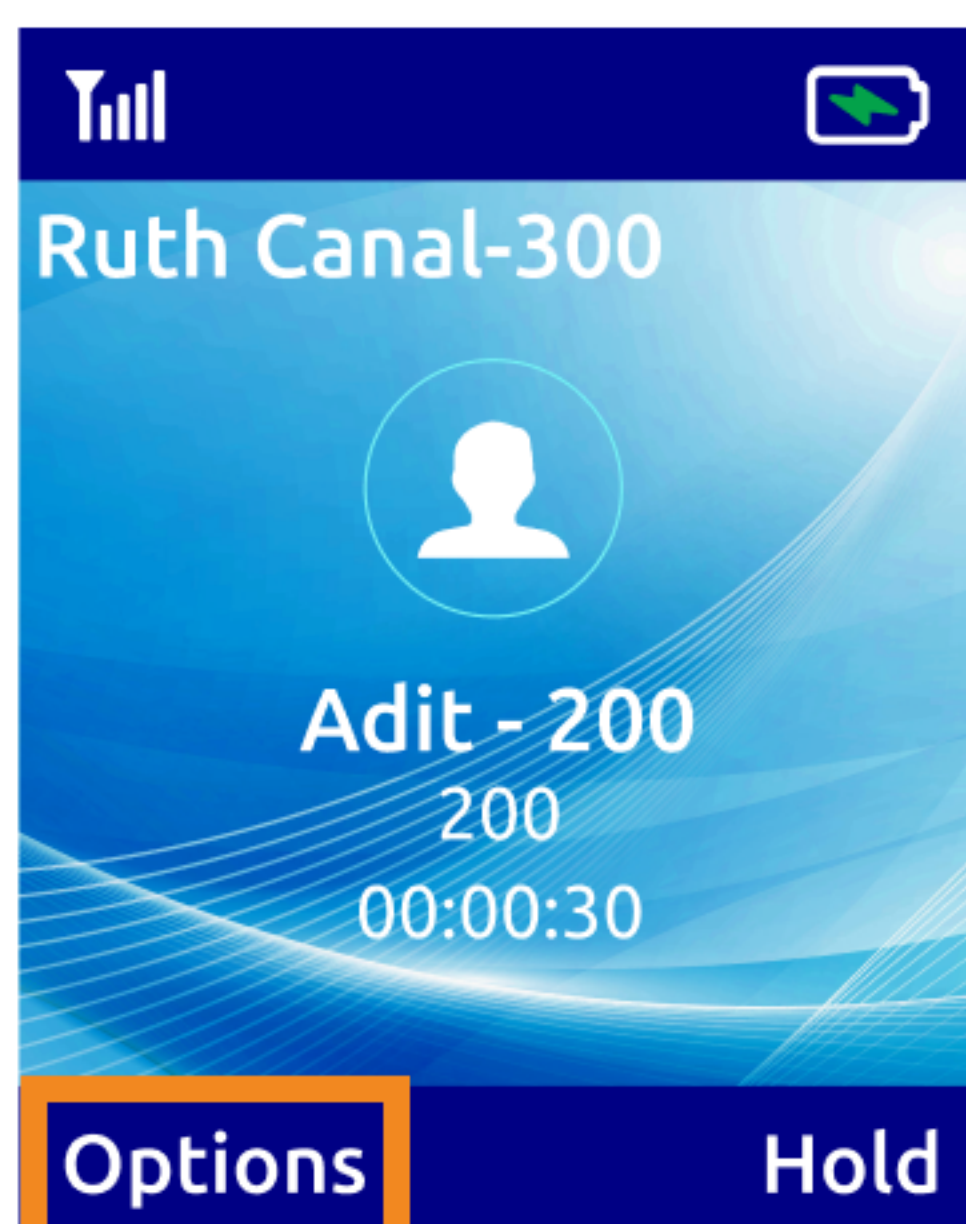

Press options while on an active call.

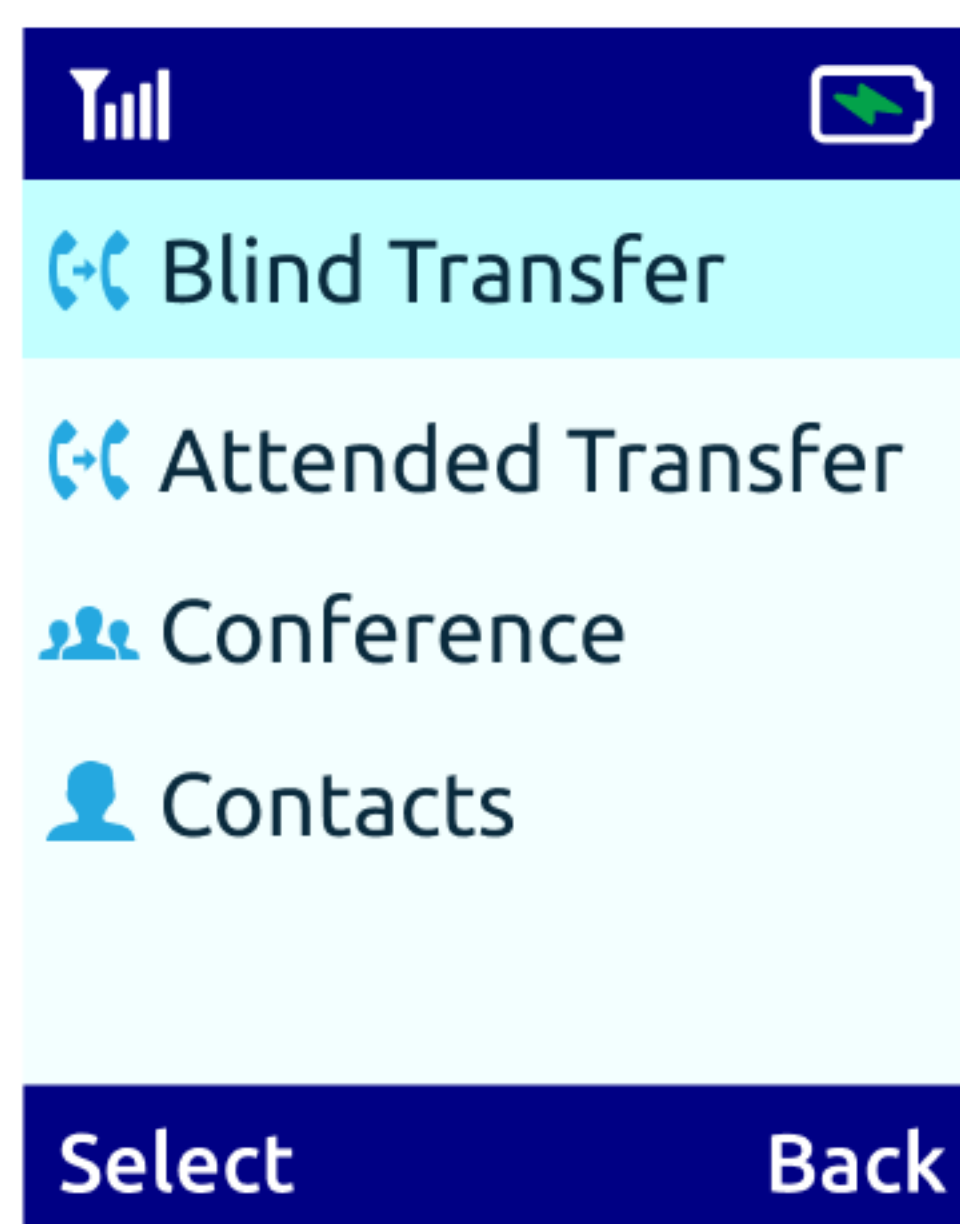

Select **blind transfer** or **attended transfer**, then enter a number and press transfer.



If using **attended transfer**, wait for the call to connect first and then press transfer.

- **3 Way Conference:**

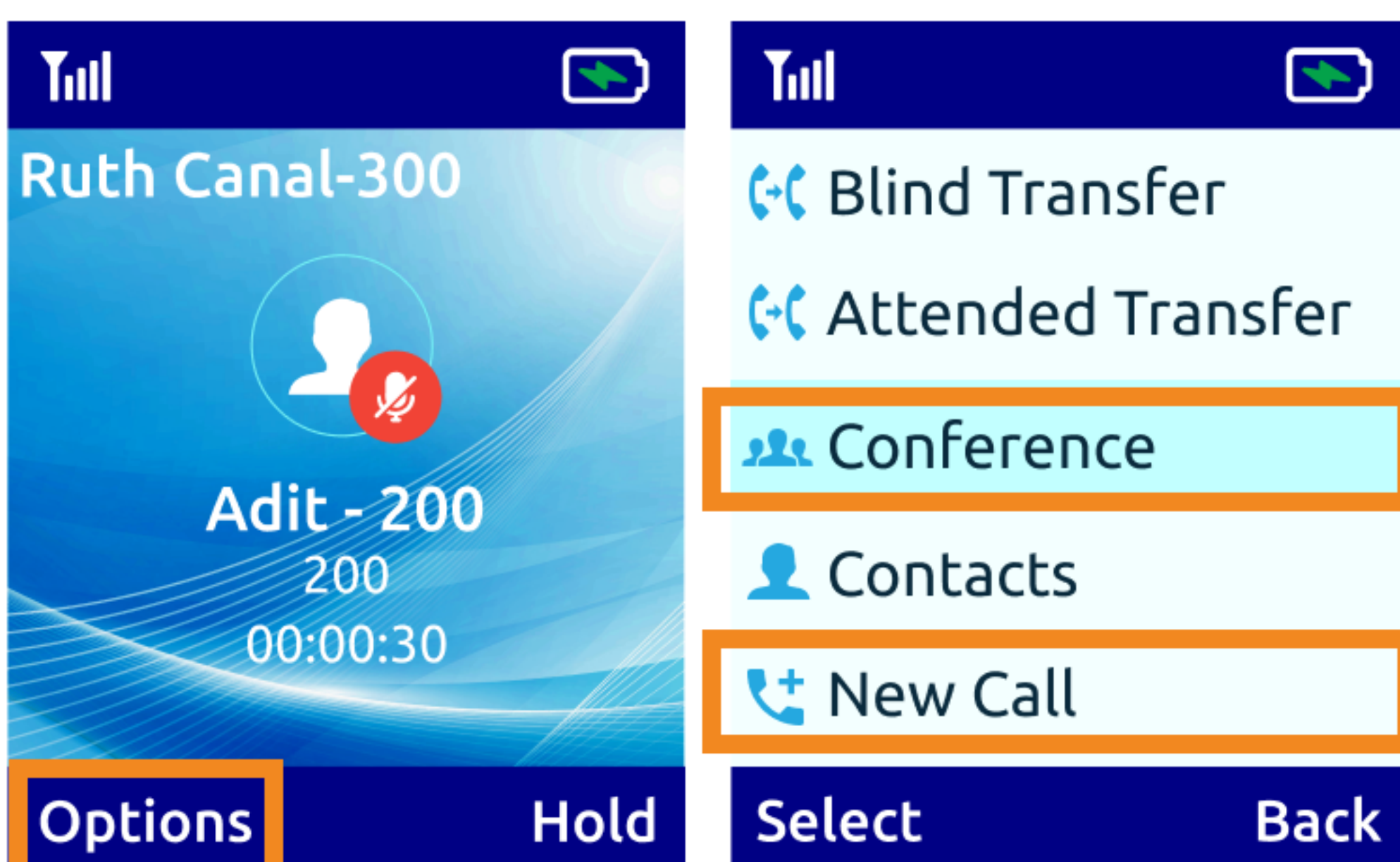

While on call, select options. Select either conference to cold conference or new call to warm conference.

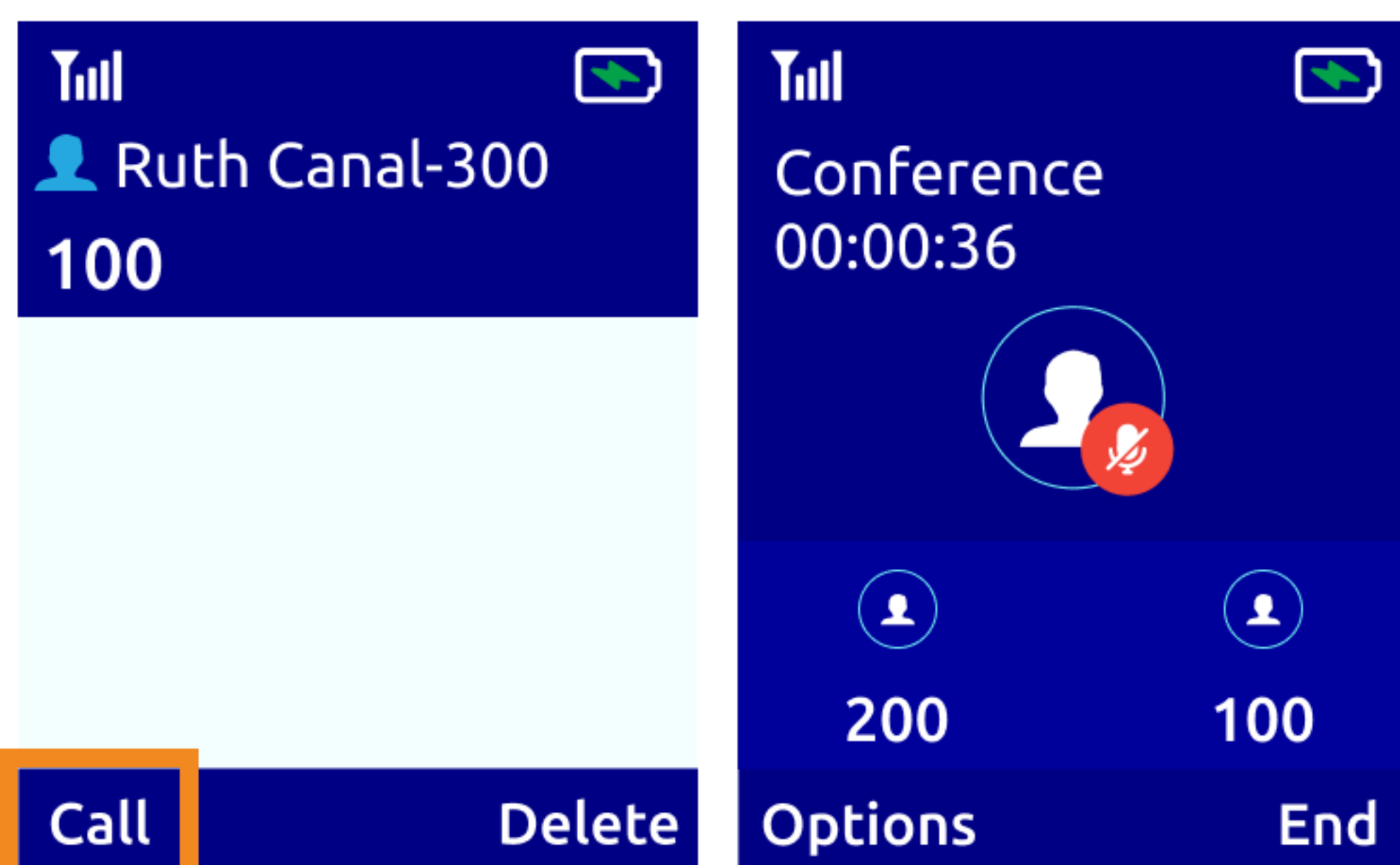

Enter a number and press call. If you selected conference, it will merge the calls immediately.

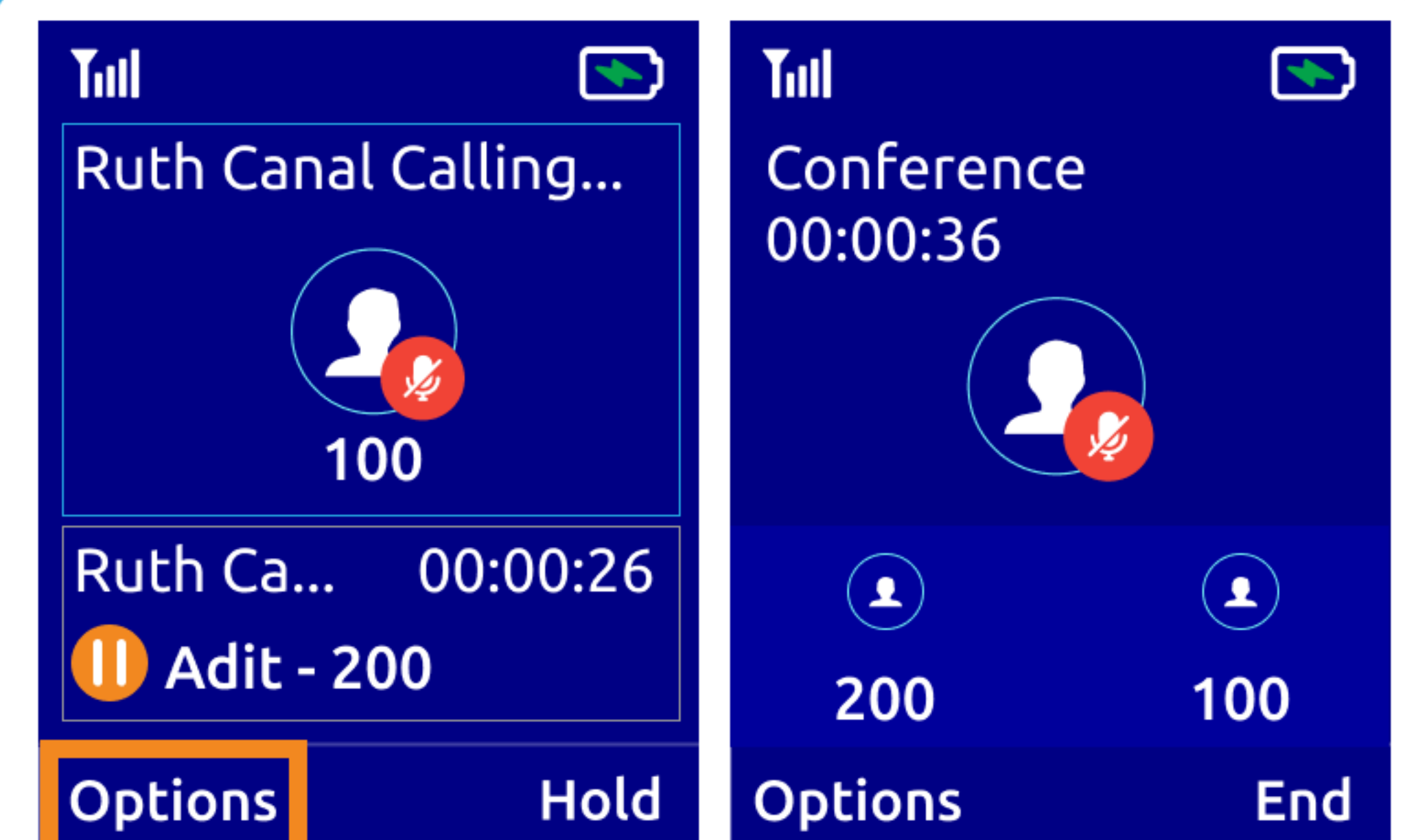

If you selected new call, wait for the call to connect first, then press options and select conference.